

CLAMPRO®



WARNING: A suitable welding headshield must be worn during use
WARNING: Read these instructions before using the machine

ARC TIG/MMA WELDER

MODEL NO: AT165

PART NO: 6012149

OPERATION & MAINTENANCE INSTRUCTIONS



ORIGINAL INSTRUCTIONS

GC0920 - ISS 2

INTRODUCTION

Before attempting to operate the machine, it is essential that you read this manual thoroughly and carefully follow all instructions given. In doing so you will ensure the safety of yourself and that of others around you, and you can also look forward to the welder giving you long and satisfactory service.

The AT165 is designed to be used for both metal ARC (MMA) and TIG welding (TIG welding leads are not supplied with the machine. These are however, readily available from your CLARKE dealer (Part number 6012233)).

SUITABILITY

MMA/Arc Welding	Carbon Steel, Low Alloy Steel, Stainless Steel, Cast Iron.
TIG Welding	Carbon Steel, Low Alloy Steel, Stainless Steel, Cast Iron, Titanium, Copper + Brass.

GUARANTEE

This CLARKE product is guaranteed against faulty manufacture for a period of 12 months from the date of purchase. Please keep your receipt as proof of purchase.

This guarantee is invalid if the product is found to have been abused or tampered with in any way, or not used for the purpose for which it was intended.

Faulty goods should be returned to their place of purchase, no product can be returned to us without prior permission.

This guarantee does not effect your statutory rights.

UNPACKING

Any damage or deficiency should be reported to your CLARKE dealer immediately. You should find inside the box the following:

- 1 x 160A ARC / TIG Inverter Welder
- 1 x Wire Brush / Hammer
- 1 x Electrode Clamp & Cable
- 1 x Earth Clamp & Cable

GENERAL SAFETY INSTRUCTIONS



WARNING: WHEN USING ELECTRICAL TOOLS, BASIC SAFETY PRECAUTIONS SHOULD ALWAYS BE FOLLOWED TO REDUCE THE RISK OF FIRE, ELECTRIC SHOCK AND PERSONAL INJURY.

WARNING: READ ALL THESE INSTRUCTIONS BEFORE ATTEMPTING TO OPERATE THIS PRODUCT AND KEEP THESE INSTRUCTIONS IN A SAFE PLACE.

ELECTRIC SHOCK

- Always remove the plug from the socket and wait 5 minutes to allow the capacitors to discharge before carrying out servicing or maintenance.
- Do not touch live electrical parts.
- Never use electrode holders or cables which are damaged.
- Keep the working environment, equipment, cables and clothing free from grease, oil, moisture and dirt.
- Ensure the welding machine has been correctly earthed.
- The operator must be insulated from the floor and work bench, using a dry insulation mat.
- Always ensure a second person is present in case of accident.
- Never change electrodes with bare hands or damp gloves.
- Keep welding cables away from power cables.
- Regularly inspect the condition of the cables for signs of damage.
- Remove the plug from the mains socket when not in use, do not leave the machine unattended.
- Ensure the earth clamp is secured to bare metal adjacent to the weld seam, and when not in use, is insulated for safety. - Keep all equipment well maintained.
- The operator shall prevent gas cylinders in the vicinity of the workpiece from becoming part of the welding circuit.

FUMES & GASES

- The welding process generates hazardous fumes as a by-product. Inhalation of these fumes is hazardous to health.
- Keep your head away from the weld to avoid breathing the fumes.
- If welding in confined spaces, ensure adequate ventilation and use a fume extractor.
- By-products of welding can react to create a toxic/explosive environment.

FIRE OR EXPLOSION

Welding can cause fires and explosions. Precautions should be taken to prevent these hazards.

- Before starting work ensure the area is clear of flammable materials.
- Move any combustible materials to a safe distance, especially substances likely to generate a dangerous vapour.
- The welding arc can cause serious burns. Avoid contact with the skin.
- Sparks and molten metal are ejected during welding. Take precautions to prevent fire.
- Sparks and molten metal can pass through gaps. Be aware that fire can start out of sight.
- Do not weld pressurised containers, or containers containing flammable vapours e.g. fuel tanks.
- Always have appropriate fire fighting equipment to hand suitable for use in electrical environments.

- Avoid carrying any fuels with you e.g. cigarette lighters or matches.

PERSONAL PROTECTION

- The body should be protected by suitable clothing.
- The use of neck protection may be necessary against reflected radiation.
- Arc welding machines generate a magnetic field which is detrimental to pacemakers. Consult your doctor before going near active welding equipment/operations.
- The UV and IR radiation generated by welding is highly damaging to the eyes, causing burns. This can also affect the skin.
- Always use a suitable welding shield equipped with appropriate protective filters.
- Where there are pedestrians and traffic, ensure a protective screen is used to avoid accidental arc glare.
- Do not weld in the vicinity of children or animals and ensure no one is looking before striking an arc.
- Wear hearing protection if required.
- Allow the weld time to cool. Hot metal should never be handled without gloves.
- Take care when adjusting or maintaining the torch. Make sure it has had time to cool sufficiently and the welder is disconnected from the mains supply.
- First aid facilities and a qualified first aid person should be available unless medical facilities are close by, for immediate treatment of flash burns of the eyes and for skin burns.
- A hard hat should be worn when others are working overhead.
- Flammable hair sprays/gels should not be used by persons intending to weld or cut.

PROTECTIVE CLOTHING

- Wear gauntlet gloves designed for use in welding.
- Wear an apron and protective shoes.
- Wear cuffless trousers to avoid entry of sparks and slag.
- Avoid oily, greasy clothing.
- Protective head and shoulder coverings should be worn when overhead welding.
- Wear a welding headshield with appropriate filter lenses or plates (protected by clear glass). This is a MUST for welding (and chipping) to protect the eyes from radiant energy and splatter. Replace cover glass when broken, pitted, or splattered.

NOTE: ALL protective wear inc. masks & head shields MUST comply with PPE Directive 89/686/EEC

ADDITIONAL SAFETY PRECAUTIONS FOR ARC WELDERS







- NEVER attempt to remove any of the exterior panels unless the machine is disconnected from the power supply.
- NEVER use the machine with any of the panels removed.
- NEVER attempt any electrical or mechanical repair unless you are a qualified technician. If you have a problem with the machine contact your local CLARKE dealer.
- NEVER use or store in a wet/damp environment. DO NOT EXPOSE TO RAIN.
- NEVER allow children or animals in the vicinity of a welding operation.
- ALWAYS remove all flammable materials from the welding area.
- ALWAYS ensure that there is full free air circulating around the outer casing of the machine, and that the louvres are unobstructed.
- The welding arc can seriously damage your eyes. Both the operator and any spectators should always use a proper welding face shield or helmet, with

suitable filter lenses. Proper gloves and working clothes should be worn at all times.

- ALWAYS wear a pair of safety spectacles/goggles when chipping away slag after welding. Remember, ordinary eye glasses are not safety gasses.

- ALWAYS ensure there is a fire extinguisher on hand.
- ALWAYS ensure there is adequate ventilation or extraction in the work area, as the welding process gives off toxic fumes.
- ALWAYS ensure that a medical supply is on hand, and that treatment for burns is available.

SAFETY SYMBOLS

	Read this instruction booklet carefully before use.		Do not expose to rain.
	Wear eye protection		Recycle unwanted materials instead of disposing of them as waste. All tools, accessories and packaging should be sorted, taken to a recycling centre and disposed of in a manner which is compatible with the environment.
	Wear protective gloves		
	Wear a dust mask		

ENVIRONMENTAL RECYCLING POLICY



Through purchase of this product, the customer is taking on the obligation to deal with the WEEE in accordance with the WEEE regulations in relation to the treatment, recycling & recovery and environmentally sound disposal of the WEEE.

In effect, this means that this product must not be disposed of with general household waste. It must be disposed of according to the laws governing Waste Electrical and Electronic Equipment (WEEE) at a recognised disposal facility.

ELECTRICAL CONNECTIONS



WARNING: READ THESE ELECTRICAL SAFETY INSTRUCTIONS THOROUGHLY BEFORE CONNECTING THE PRODUCT TO THE MAINS SUPPLY.

Connect the mains lead to a standard, 230 Volt (50Hz) electrical supply through an approved 13 amp BS 1363 plug, or a suitably fused isolator switch.

If the plug has to be changed because it is not suitable for your socket, or because of damage, it must be removed and a replacement fitted, following the wiring instructions shown below. The old plug must be discarded safely, as insertion into a power socket could cause an electrical hazard.



**WARNING: THE WIRES IN THE POWER CABLE OF THIS PRODUCT ARE COLOURED IN ACCORDANCE WITH THE FOLLOWING CODE:
BLUE = NEUTRAL BROWN = LIVE YELLOW AND GREEN = EARTH**

If the colours of the wires in the power cable do not agree with the markings on the plug.

- The BLUE wire must be connected to the terminal which is marked N or coloured black.
- The BROWN wire must be connected to the terminal which is marked L or coloured red.
- The YELLOW AND GREEN wire must be connected to the terminal which is marked E or  or coloured green.

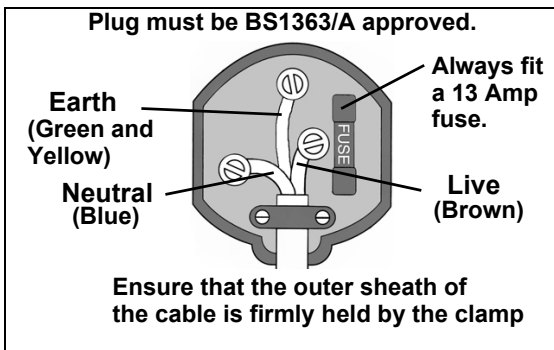

We strongly recommend that this machine is connected to the mains supply through a Residual Current Device (RCD)

If you are not sure, consult a qualified electrician. DO NOT try to do any repairs.

CABLE EXTENSION

Always use an approved extension cable suitable for the power rating of this tool (see specifications), the conductor size should also be at least the same size as that on the machine, or larger. When using a cable reel, always unwind the cable completely.

If a cable extension is needed it is essential to comply with the following data.

Voltage	Extension length	Cable section
230V	up to 20 m	2.5 mm ²
230V	20 - 50 m	4 mm ²

MMA/ARC WELDING

A consumable electrode is connected to a high amperage low voltage supply which creates an electric arc between the electrode and the workpiece.

Benefits over TIG welding include, less experience needed, torch kit or shielding gas are not required.

PREPARATION

- Arc welding cables are supplied with this machine.

To prepare the unit for ARC welding, it is important that you follow the procedure below.

1. Making sure that the ON/OFF switch, located on the rear panel is in the OFF position, connect the welding leads as follows:
 - Welding rod holder lead to the +ve terminal.
 - Work clamp lead to the -ve terminal.
2. Select the appropriate welding rod and insert it into the welding rod holder.
 - The size (diameter) of the welding rod should be approximately the same as the thickness of metal to be welded.
3. Attach the work clamp to the workpiece as close as possible to the area being welded. Clean with a wire brush where necessary to ensure the connection is as clean as possible.
4. Set the required current using the current selector.
 - With practice you will gain a feel for the correct current setting for different welding rod thicknesses.
 - The following table gives a useful guideline.

Material Thickness	Welding Rod Size	Current (Amps)
1-2 mm	2.5 mm	70 - 100
2-5 mm	3.2 mm	100 - 125
5-8 mm	4.0 mm	125 - 160

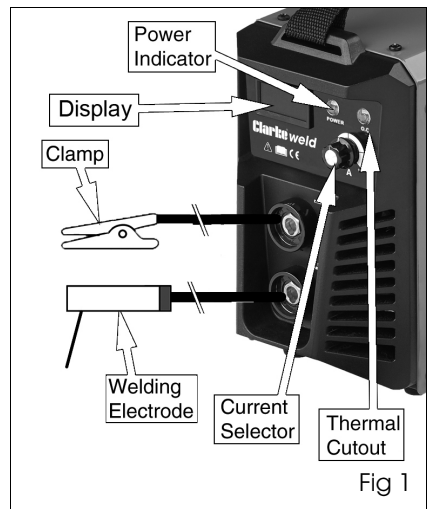

Fig 1

5. Switch ON using the switch located on the rear panel.
 - The green light on the front panel should glow, indicating the machine is ON.
 - If the machine stops at any time and the amber light comes ON, the thermal overload device has intervened. Wait until the welder has cooled sufficiently (the amber light goes out) before restarting work.

STRIKING THE ARC - WELDING



WARNING: WHEN WELDING ALWAYS ENSURE THERE IS ADEQUATE VENTILATION IN THE WORK AREA AS THE WELDING PROCESS GIVES OFF TOXIC FUMES.



WARNING: ALWAYS USE A SUITABLE WELDING MASK OR SHIELD WHEN USING ANY WELDER.

The most difficult aspect of the arc welding process, particularly for beginners, is that of striking an arc. We strongly recommend that you practice on some pieces of scrap metal to get the feel of the operation, before you start on an actual welding job.

1. Hold the electrode about 10 mm from the work and at an angle of about 70° to 80° to the work surface; take care not to accidentally touch the workpiece until you are ready to start.
2. Holding the welding mask close-up to your face, give a short stroke with the electrode on the workpiece. As soon as the arc is primed, withdraw the electrode from the workpiece to leave a tiny gap of around 1.5mm (1/16"). The current will flow across the gap with a crackling noise and a brilliant arc. Continue to weld in one direction, maintaining the small gap as you go.

NOTE: When you prime the arc, be sure to withdraw the electrode swiftly to leave the 1.5 mm. gap, otherwise the electrode will weld itself to the workpiece. If this occurs give the electrode a short sharp jerk to free it and, if necessary, prime the arc again. If you cannot free the electrode, switch the machine off immediately and free it. Take care the electrode will get red hot very quickly and will be capable of burning through welding gloves.

3. At the end of the run, just lift the electrode away from the workpiece.
 - Inspect the job carefully. Any slag forming on the surface should be chipped away with a chipping hammer or pick. ALWAYS wear your safety goggles when chipping away slag.

TIG WELDING

TIG welding is primarily for very thin materials. It uses a non-consumable tungsten (or tungsten alloy) electrode, held in a torch.

A shielding gas (100% Argon), is fed through the torch to protect:

- The electrode,
- Molten weld pool,
- Solidifying weld metal from contamination by the atmosphere.

The electric arc is produced by the passage of current through the conductive, ionized shielding gas. The arc is established between the tip of the electrode and the work. Heat generated by the arc melts the base metal. Once the arc and weld pool are established, the torch is moved along the joint and the arc progressively melts the joined surfaces. Filler wire, if used, is usually added to the leading edge of the weld pool to fill the joint.

This process is ideally suited for welding thin metals such as car body panels, pressure vessels, heat exchangers, pipes etc., where accuracy and a high quality weld is desired, as it produces a very low porosity weld.

MAIN FEATURES OF TIG WELDING

1. Electronic control of welding current.
2. Forced air cooling.
3. A thermal overload protection device prevents overheating.

TIG WELDING PROCESS ADVANTAGES

- It produces superior quality welds, generally free of defects.
- It is free of the spatter which occurs with other arc welding processes.
- It can be used with or without filler metal as required.
- It allows excellent control of root pass weld penetration.
- It can produce welds at high speeds.
- It allows precise control of the welding variables.
- It is capable of welding very thin material (0.5mm), without undue distortion.

LIMITATIONS

1. Greater weld dexterity is required.
2. These units have a DC output which is not suitable for welding aluminium.

TIG WELDING (REF FIG.2)

- The machine is not equipped with a TIG welding torch and cables; these are available from your Clarke dealer (Part number 6012232).
- Additionally, before TIG welding, you must obtain a gas cylinder of 100% pure Argon.

To prepare the unit for TIG welding, it is important that you adopt the following procedure.

1. Plug the work clamp lead in to the +ve terminal, and secure the work clamp to the workpiece.
 - For good contact, the work clamp must be attached to clean bare metal. Clean with a wire brush where necessary.
2. Plug the torch lead to the -ve terminal.

3. Screw the pressure regulator on to the gas bottle tightly, and attach the gas hose to the inlet connector securely, with a hose clip.

4. Turn the pressure regulator knob to set a pressure of approx. 2.5kg/cm² (35 lbf/in²).

5. Ensure the electrode at the torch nozzle, protrudes by 4 - 5mm, also ensure that the electrode is sharply pointed with an angle of 40°-60°, if it is not, grind it to shape. (Consult your TIG Torch manual for the procedure for adjusting the electrode).

6. Set the welding current in accordance with the thickness of the material to be welded and the size of tungsten electrode to be used, (See page 12).

7. Switch ON using the switch mounted on the rear panel. The green light on the front panel will glow.

8. If the machine stops at any time and the amber light comes ON, the thermal overload has intervened. Wait until the welder has cooled sufficiently (the amber light goes out) before restarting work.

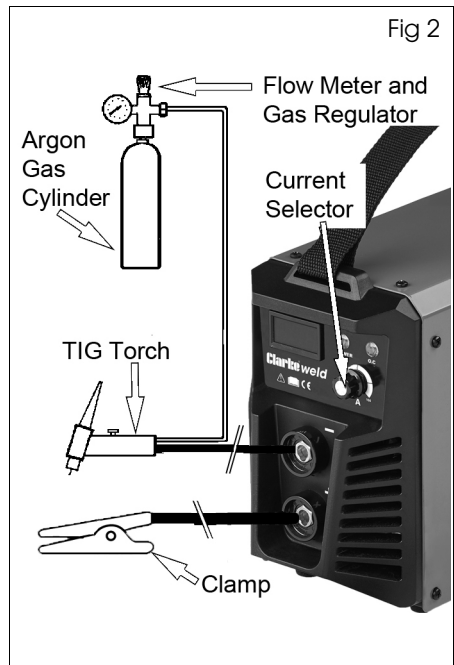

9. Open the gas valve on the torch handle,
 - This will allow gas to flow from the torch nozzle.
10. Cover your face with the head shield, bring the torch to within 3-4mm of the work, and at an angle of 45°, so that the ceramic nozzle gently touches the work surface. See fig. 3.

Fig 3

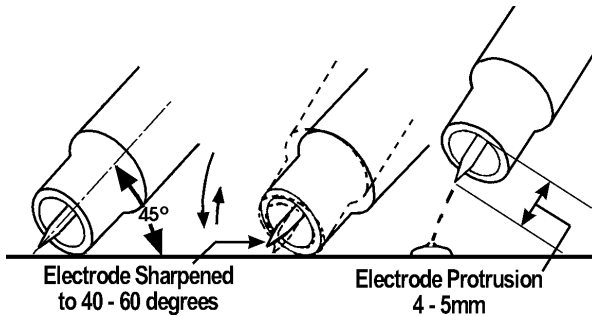

11. Scratch the tip of the electrode against the piece to be welded, as soon as the welding arc starts, remove the electrode to a distance of 3-4 mm, and continue the weld. (See notes below).
 - This method is referred to as 'Scratch Arc'.
12. To stop welding, simply remove the torch from the workpiece.
13. Turn OFF the gas as soon as you finish welding.

NOTE:

- To avoid a visible strike mark on the surface of the workpiece, it is advisable to strike the arc in the joint, where the mark will be concealed by the weld.
- Thin sheet and stainless steel may be welded with or without filler, similar to gas welding.
- The filler is fed in at the edge of the pool. The rod must not touch the tip of the electrode or enter the arc. The end of the rod must always be shielded by the argon atmosphere to prevent as far as possible the formation of oxides of its surface. When welding stainless steel and copper, it is often possible to feed in the filler continuously at the edge of the pool.
- The arc length generally varies between 3 and 6 mm depending on the type of joint, type and thickness of material, and so on.
- The torch is advanced in the direction of welding, without lateral movement, maintaining the torch angle of 45° to the workpiece.

Guidelines for the TIG welding current needed and recommended electrode sizes etc. for different gauges of material are shown in the chart below:

Metal	Welding Current (Amps)	Workpiece Thickness (mm)	Filler Rod Dia (mm)	Welding Electrode Dia (mm)	Gas Flow ltr/min
Mild Steel	20-30	1	0-1	1.6	4-5
	60-80	2	1.2-1.6	1.6	4-5
	80-110	3	1.6-2.0	1.6/2.4	4-5
	100-130	3.5	2.0-2.4	2.4	5-6
	130-140	4	2.4	2.4	6-7
	140-150	4.5	2.4	2.4	7-8
	150-160	5	2.4	2.4	7-8
Stainless Steel	15-35	1	0-1	1.6	4-5
	60-80	2	1.2-1.6	2.4	4-5
	80-115	3	1.6-2.0	1.6/2.4	4-5
	100-130	3.5	2.0-2.4	2.4	5-6
	130-140	4	2.4	2.4	6-7
	140-150	4.5	2.4	2.4	7-8
	150-160	5	2.4	2.4	7-8
Copper	80	2	2.0	1.6	5-6
	125	3	2.4	2.4	5-6
	135-150	4	2.4	2.4	6-7
	150-160	4.5	2.4	2.4	7-8

WELDING PITFALLS

The arc welding technique is an acquired skill and requires considerable practice before perfect results are obtained. The diagrams below will help to explain the pitfalls in your technique and how to overcome them.

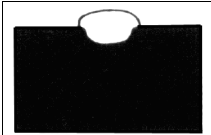

ARC TOO SHORT

This causes irregular masses of weld to be deposited, with slag contamination on an uneven surface.

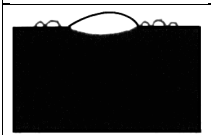

ARC TOO LONG

This causes poor penetration resulting in a weak weld with excessive spatter and porosity. Surface of the weld is rough and the arc makes a hissing sound

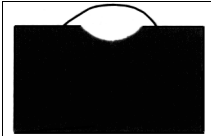

ELECTRODE MOVED TOO SLOWLY

This causes a very wide and heavy deposit which overlaps at the sides. It is wasteful both in terms of time and electrode use.



ELECTRODE MOVED TOO QUICKLY

This causes poor penetration with a 'stringy' and incomplete weld deposit. Slag is very hard to remove.

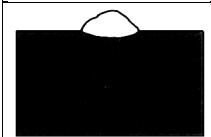

CURRENT TOO LOW

This causes poor penetration and causes the electrode to stick to the workpiece too readily. Also results in a very irregular and high weld deposit. Slag is very hard to remove.

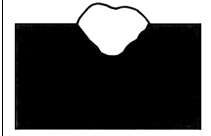

CURRENT TOO HIGH

This causes excessive penetration with spatter and deep pointed crater. It may also cause holes to be burned in the workpiece.

Burns electrodes very quickly.

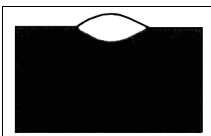

THE PERFECT WELD

With the correct combination of arc length, current regulation, inclination and speed of the electrode, you will, with practice, produce the perfect weld.

This should be regular with uniform ripples and no slag contamination. The arc will make a steady crackling sound.

TROUBLESHOOTING

DEFECT	CAUSES	SUGGESTIONS
Spark will not start	Bad clamp connection. Inverter printed circuit is defective.	Check clamp connection. Contact your nearest CLARKE dealer.
No output voltage	Overheated machine (the yellow LED should be on).	Wait for thermal cutout to be reset.
	Under-voltage/over-voltage limits exceeded. Yellow LED on and green LED flashing.	Check the mains distribution system. Wait for internal check of input voltage. When this is within normal limits, the yellow LED will go out and the green LED will stay on.
	Internal relay has failed.	Contact your nearest CLARKE dealer.
	Inverter printed circuit is defective.	Contact your nearest CLARKE dealer.
Wrong output current	Current selector control is defective.	Contact your nearest CLARKE dealer.
	Low power supply voltage.	Check the mains distribution system.
Porosity of welds	Acid electrode on steel with high sulphur content. Electrode oscillates too much. Workpieces are too far apart. Workpiece being welded is cold.	Use basic electrode. Move edges to be welded closer together. Move slowly at the beginning.
Cracks in weld	Material being welded is dirty (e.g.oil, paint, rust, oxides). Not enough current.	Clean workpiece before welding is an essential method of achieving neat weld beads.
Limited penetration	Low current, high welding rate, reversed polarity. Electrode inclined in position opposite to it's movement.	Ensure operating para - meters are regulated and improve preparation of work pieces.

DEFECT	CAUSES	SUGGESTIONS
High Sprays	Electrode is too inclined.	Make appropriate corrections.
Profile defects.	Welding parameters are incorrect. Pass rate is not related to operating parameter requirements. Electrode not inclined constantly while welding.	Follow basic and general welding principles.
Arc is unstable.	Insufficient current.	Check condition of electrode and earth wire connection.
Electrode melts obliquely.	Electrode core is not centred. Magnetic blow phenomenon.	Replace electrode. Connect two earth wires to opposite sites of the work piece.

MAINTENANCE

WARNING: DISCONNECT FROM MAINS BEFORE CLEANING.



WARNING: DO NOT ATTEMPT TO CARRY OUT REPAIRS YOURSELF, UNLESS YOU ARE FULLY COMPETENT, ALL WORK MUST BE CARRIED OUT BY A QUALIFIED TECHNICIAN.



The welder, requires very little maintenance other than the following guidelines. Under normal working conditions removing the covers and cleaning with dry compressed air at reduced pressure once a year will be quite sufficient. Cleaning at more frequent intervals is advisable however, if the unit is operating in a dusty and dirty environment.

1. Keep the louvres clean to avoid a build up of dirt and oxides inside the machine, which can reduce machine output.
2. Check all cables periodically for condition and secure. They must be in good condition and not cracked.
3. Always avoid getting particles of metal inside the machine since they could cause short circuits.

RATING PLATE

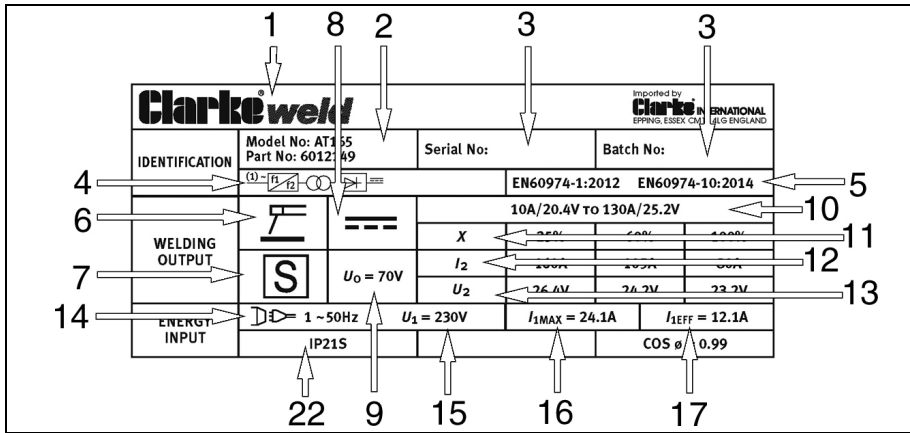

1	Name and address of manufacturer	12	Rated Welding Current Symbol
2	Model Number, / Part Number	13	Conventional Load Voltage Symbol
3	Serial / Batch Number	14	Energy Supply Symbol
4	Welding Power Source	15	Rated Supply Voltage
5	British Standards applied	16	Rated Maximum Supply Current
6	Welding Process Symbol	17	Maximum Effective Supply Current
7	This symbol indicates that the unit is suitable for carrying out welding operations in an environment which has an increased risk of electric shock.	18	N/A
8	Welding Current Symbol	19	N/A
9	Rated No-load Voltage	20	N/A
10	Range Of Output	21	N/A
11	Duty Cycle Symbol	22	Degree of Protection

DUTY CYCLE

This welder is covered by regulations BS EN 60974-1:2012, where the Duty Cycle (X) is expressed as a percentage of time the machine may be used in a given period for a specified welding current.

i.e. When welding at 105 Amps the machine may be used for 6 minutes (60%) in any 10 minute period,

SPECIFICATIONS

	AT165
Unpacked Weight (kg)	7.85
Dimensions (l x w x h) (mm)	380 x 152 x 236
Power Supply	230V AC~ 50Hz
Rated Max Input Current (A) I1Max / I1eff(A)	24.1 / 12.1
No Load Voltage (V)	Uo=70V
Max/Min Welding Current (A)	10A/160A
IP Rating	IP21S
Suitable Electrodes (mm)	2.5 + 3.2 +4.0

NOTE: The details and specifications contained herein, are correct at the time of going to print. However, CLARKE International reserve the right to change specifications at any time without prior notice.

ACCESSORIES

The following are some of the accessories available from your CLARKE dealer. Please quote the part numbers shown below:

DESCRIPTION	PART NUMBER
Range of Arc Activated Welding Headshield	See Your Clarke Dealer
2.5 mm Arc Welding Electrodes	3050584
3.2 mm Arc Welding Electrodes	3050586
4.0 mm Arc Welding Electrodes	3050588
TIG Welding Torch Assembly (AT162, AT165)	6012233
Argon Gas Regulator	8134140

EXPLODED DIAGRAM & PARTS LIST AT165

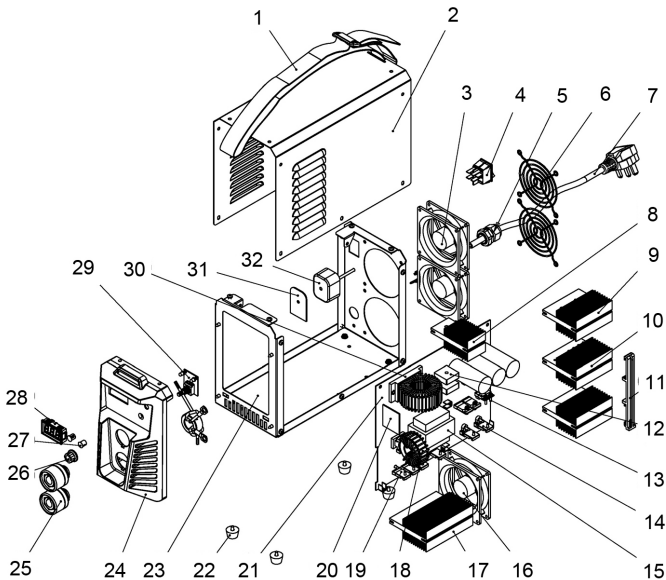

NO	DESCRIPTION	NO	DESCRIPTION
1	Strap	17	Temi160 rectifier radiator
2	Top Housing	18	Inductance
3	Fan	19	Fast recovery diode
4	Switch	20	Control PCB
5	Cable Gland	21	Main PCB
6	Fan Grille	22	Rubber Foot
7	Power Cable	23	Base Frame
8	Bridge Heatsink	24	Front Plastic Panel
9	IGBT Radiator	25	Quick connector ASM
10	IGBT Radiator	26	Knob
11	Support bar	27	Shade
12	Rectifier bridge pile	28	Digital display
13	Fast recovery diode	29	Given PCB
14	IGBT	30	PFC Inductance
15	Transformer	31	Input Common Templates
16	Fan	32	Magnetic Rings

DECLARATION OF CONFORMITY



Clarke[®]
INTERNATIONAL

Hemnal Street, Epping, Essex CM16 4LG

DECLARATION OF CONFORMITY

This is an important document and should be retained.

We hereby declare that this product(s) complies with the following directive(s):

2014/30/EU *Electromagnetic Compatibility Directive.*

2014/35/EU *Low Voltage Equipment Directive.*

2011/65/EU *Restriction of Hazardous Substances, (amended by 2015/863).*

The following standards have been applied to the product(s):

EN 60974-1:2012, EN 60974-10:2014+A1:2015.

The technical documentation required to demonstrate that the product(s) meet(s) the requirement(s) of the aforementioned directive(s) has been compiled and is available for inspection by the relevant enforcement authorities.

The CE mark was first applied in: 2015

Product Description: ARC TIG Inverter Welders 130A-160A.
Model number(s): AT133, AT162.
AT135, AT165 (*with Power Factor Correction*).
Serial / batch Number: N/A
Date of Issue: 22/09/2020

Signed:

J.A. Clarke
Director

A SELECTION FROM THE VAST RANGE OF

Clarke®

QUALITY PRODUCTS

AIR COMPRESSORS

From DIY to industrial, Plus air tools, spray guns and accessories.

GENERATORS

Prime duty or emergency standby for business, home and leisure.

POWER WASHERS

Hot and cold, electric and engine driven - we have what you need

WELDERS

Mig, Arc, Tig and Spot. From DIY to auto/industrial.

METALWORKING

Drills, grinders and saws for DIY and professional use.

WOODWORKING

Saws, sanders, lathes, mortisers and dust extraction.

HYDRAULICS

Cranes, body repair kits, transmission jacks for all types of workshop use.

WATER PUMPS

Submersible, electric and engine driven for DIY, agriculture and industry.

POWER TOOLS

Angle grinders, cordless drill sets, saws and sanders.

STARTERS/CHARGERS

All sizes for car and commercial use.



PARTS & SERVICE: 0208 988 7400

Parts Enquiries
Parts@clarkeinternational.com

Servicing & Technical Enquiries
Service@clarkeinternational.com

SALES: UK 01992 565333 or Export 00 44 (0)1992 565335

Clarke INTERNATIONAL Hemnall Street, Epping, Essex CM16 4LG
www.clarkeinternational.com